



STAY COOL
and crush your
competition with style

DRAGON
GAMING PC CASE



4 ARGB PWM
Fans



Motherboard
Compatibility



PSU
Compatibility



Maximum
Air Flow



Supports 155mm
Tower CPU Cooler

MOTHERBOARD COMPATIBILITY

With support for ATX, Micro ATX, and Mini ITX motherboards, the **Yeyian Gaming PC Case Dragoon** with Mesh Front Panel offers versatility and flexibility. It allows you to choose the motherboard that best fits your budget and needs without being limited by the case. Whether you're building a powerful gaming rig or a compact workstation, a case that supports multiple motherboard sizes can accommodate your build and make it easier to upgrade or modify your system in the future.

- Mini ITX
- Micro ATX
- ATX



OPTIMAL COOLING

The mesh front panel provides superior airflow, with room for three 120mm fans or two 140mm fans. Two additional 120mm or 140mm fans can be inserted at the top, while the power supply shroud features two 120mm fan slots to keep the power supply running efficiently. The rear is equipped with a 120mm fan for additional cooling.

2 x 140 mm
2 x 120 mm

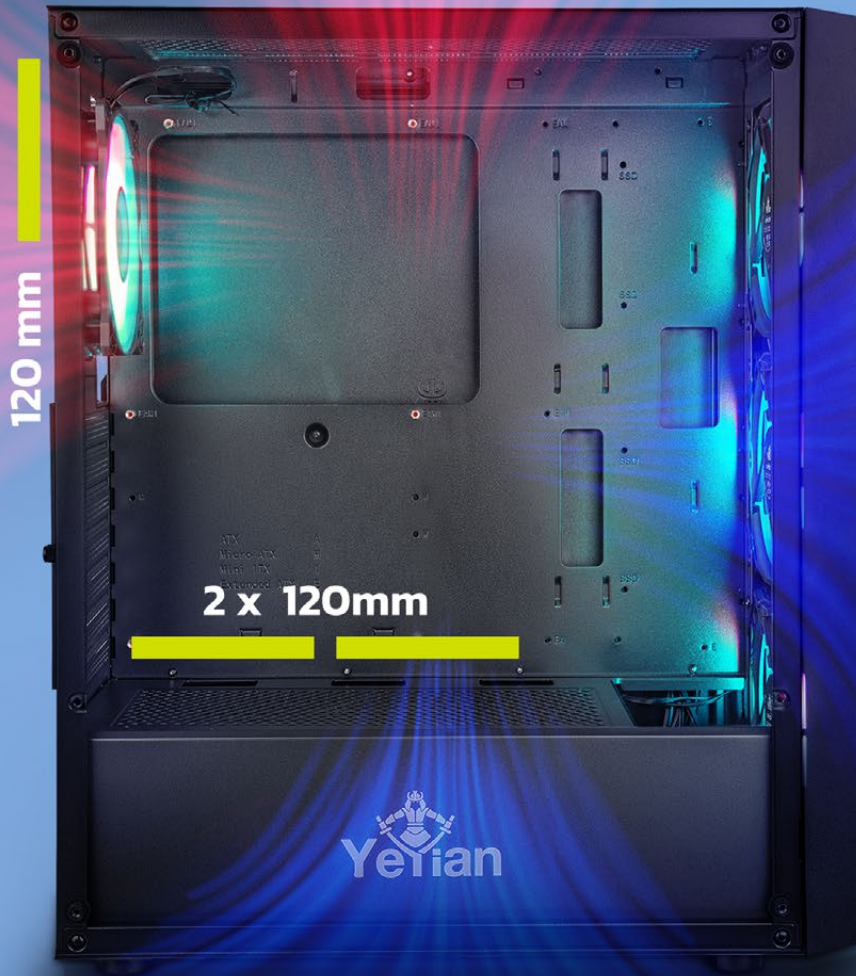

2 x 140 mm
3 x 120 mm



120 mm Fan



140 mm Fan

DESIGN TO KEEP COOL YOUR POWERFUL PC

It can perfectly fit a **155mm tower CPU** cooler for optimal performance.

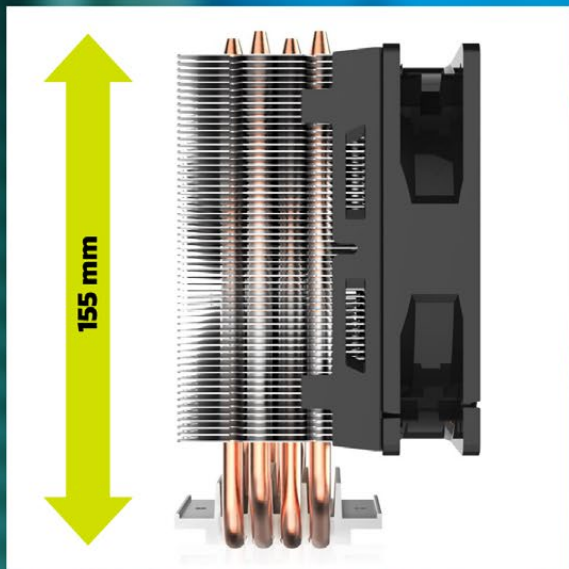

DESIGNED FOR HIGH PERFORMANCE GPUS

The Yeyian Gaming PC Case Dragoon supports 3-slot graphics cards with a length of 320–345mm, allowing you to upgrade your graphics card and have plenty of space for high-performance components.

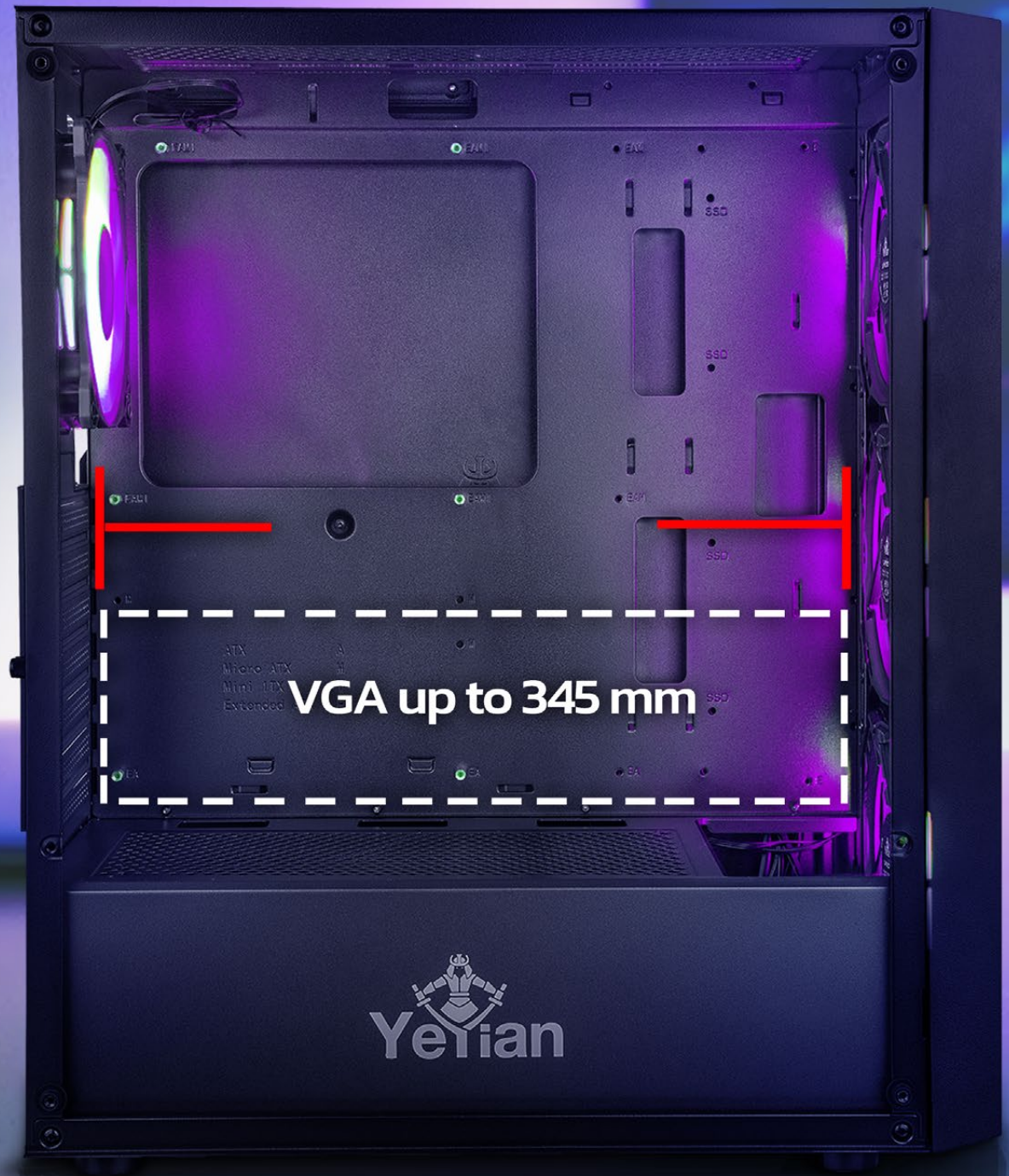



KEEP IT MANAGEABLE

Yeyian's Gaming PC Case Dragoon has space for two 2.5" SSDs and two hidden slots for 3.5"

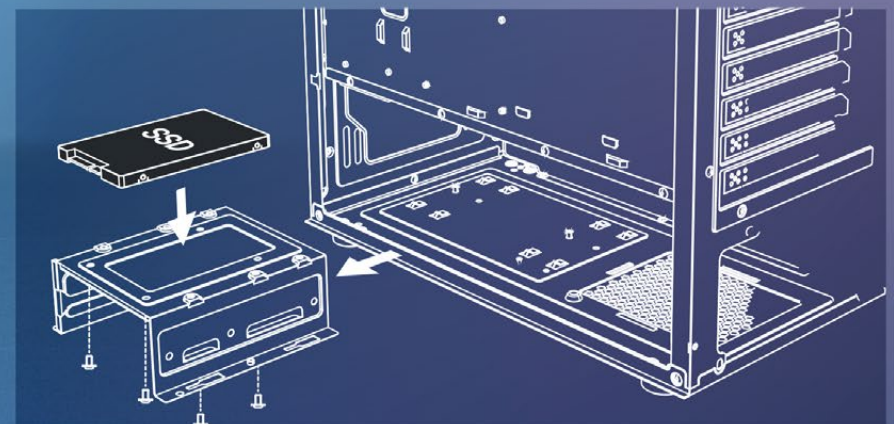
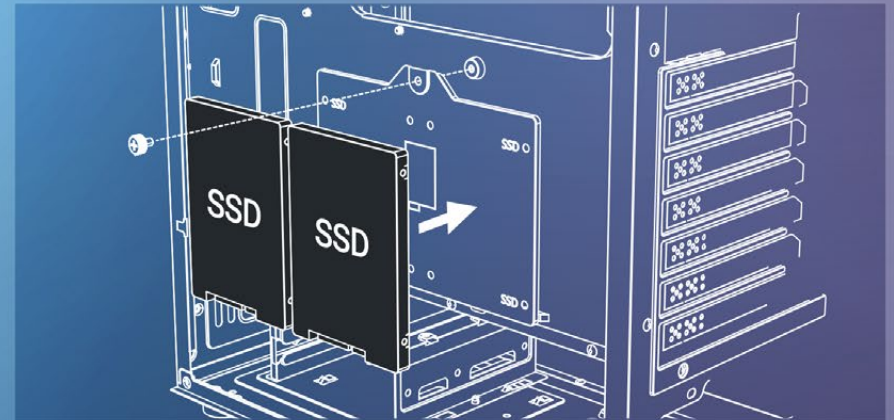

ELEGANT AND SLEEK

The clear glass side panel not only adds a sleek, modern aesthetic to your gaming setup, but also allows you to showcase your computer's high-end components and RGB lighting. You can easily monitor the performance of your system.

Thanks to the front mesh panel, your gaming computer will have improved airflow and cooling, since it allows a greater volume of air to pass through, which guarantees efficient cooling of your components.



TAKE CONTROL

Yeyian's Gaming PC Case Dragoon comes equipped with four fans (three front and one rear) with PWM and ARGB technology for optimal cooling and impressive lighting effects.

Take command with the included remote control, effortlessly customizing lighting effects. Upgrade your gaming setup with this sleek and powerful gaming PC case for the ultimate gaming experience!

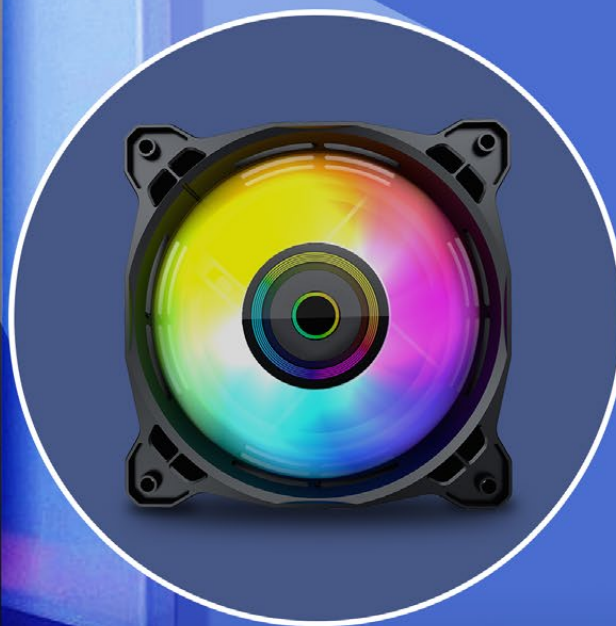

**Fan Control
Included**

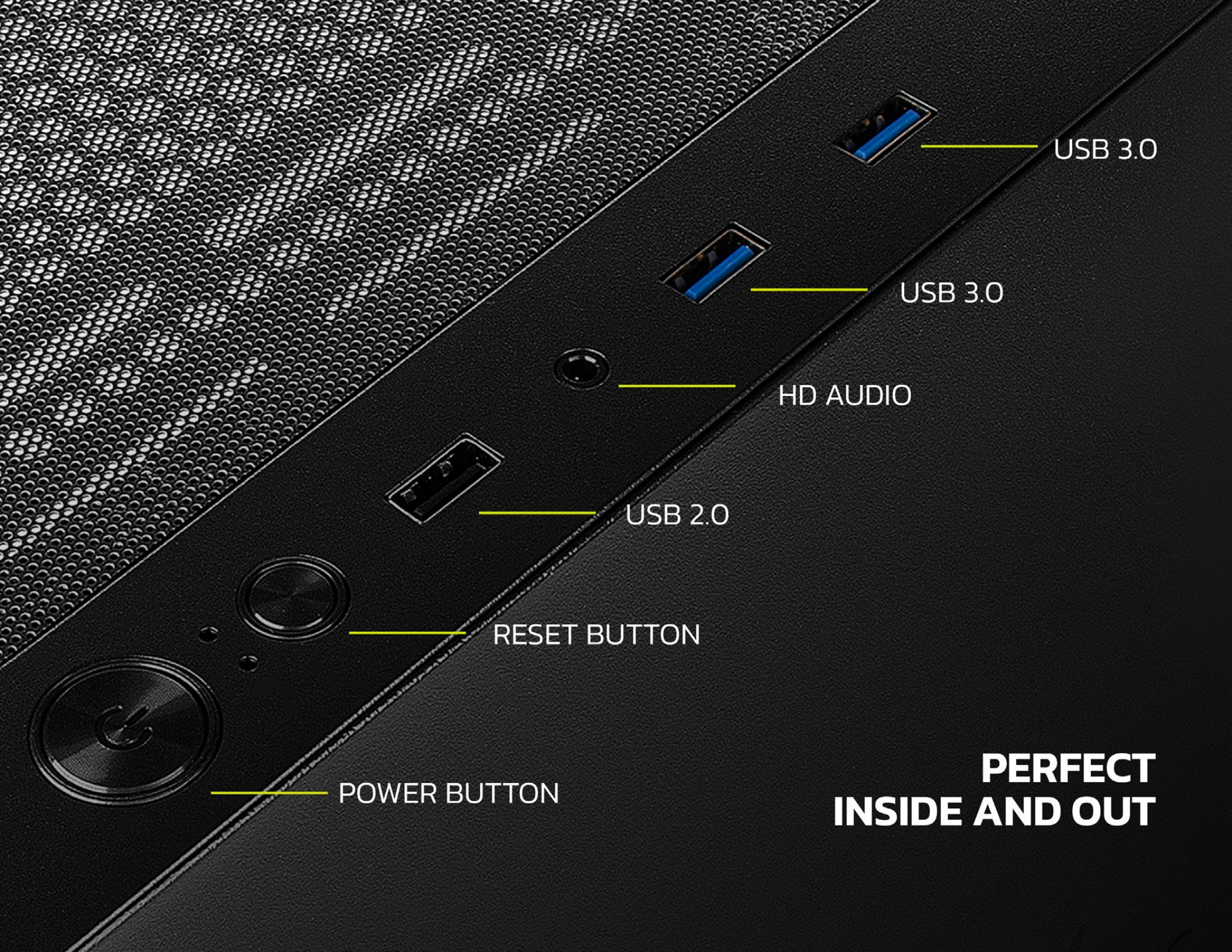

USB 3.0

USB 3.0

HD AUDIO

USB 2.0

RESET BUTTON

POWER BUTTON

**PERFECT
INSIDE AND OUT**

DRAGOON

GAMING PC CASE



Installation Kit



Remote control



4 * 120 mm Fans



User Manual



Warranty

SPECIFICATIONS

Model	YCM-APDRA-01
Motherboard	ATX, Micro ATX, Mini ITX
Panels	Front: Mesh / Side: Tempered Glass with 4 screws
Number of fans	Front: 3 x 120mm or 2 x 140mm / Top: 2 x 120mm or 2 x 140mm / PSU Shroud: 2 x 120mm / Back: 1x 120mm
VGA Size	13.5 inches or 12.5 inches with fan installed
Type	Mid Tower
Form factor	ATX
Case Material	0.5MM SPCC
Expansion Slots	7
Slots 2½" SSD	2
Hidden Slots 3½"	2
Cables management	21 mm
PSU compatibility	ATX
Front Ports	2 USB 3.0 ports, 1 USB 2.0 port, HD Audio
Fans Included	Fans with PWM and ARGB, fan speed 700~1600 RPM / 3 pieces on front, 1 piece on the back
Power Supply	ATX with customized logo on the shroud
CPU cooler height	6.1 inches
Liquid cooler	Front: compatible with 120 / 240/ 280/ 360mm radiators / Back: compatible with 120mm radiator
Dimensions	Chassis: 13.77 x 7.87 x 17.32 inches / PC Case: 15.35 x 7.87 x 17.71 inches
Weight	NW: 9.47 pounds / GW: 11.24 pounds
Content	Installation kit, 4 * 120mm fans, fan hub and remote control (4 pin for PWM and 3 pin for ARGB) user manual and warranty
Additional characteristics	Compatible with ATX PSU < 6.49 inches (with HDD installed) or < 11.81 inches (without HDD) / case protection with EPE foam, Dust filter in top and bottom
Warranty	USA and MX 2 years, Spain 3 years